

FILM ONE PAGER

SCIENCE IN CINEMA

CHEMISTRY IN CINEMA

ENGINEERING IN

MATH IN CINEMA

BIOLOGY IN CINEMA

GEOLOGY AND CLIMATE CHANGE IN CINEMA

Blade
The
Jur
Bios
Bl
Th
Ex
Hid
G
Bl
A
Blade
The in
The theo

The happening

Dante's peak
Journey to the center of the earth
The day after tomorrow
The core
2012
I am legend
Angels and demons
Inferno

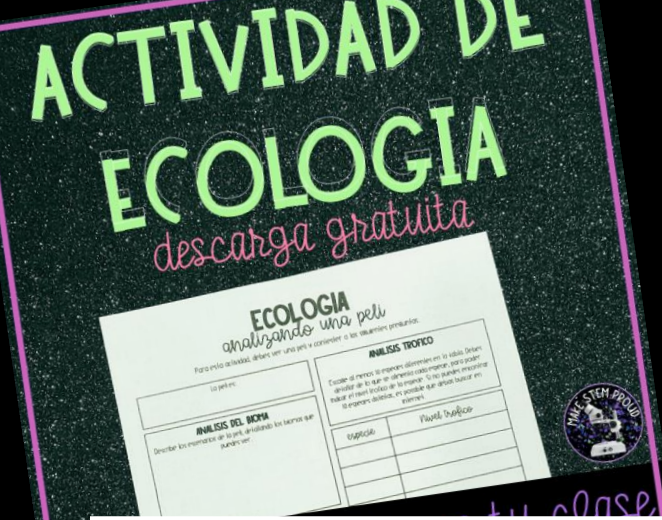

Inscríbete en la lista de correos haciendo click aquí para obtener acceso instantáneo a descargables, y para no perderte los trucos y actividades semanales.



Instructions

This resource contains everything you need to create an assignment of a one-pager for your students.

I have given you a list of possible films according to your subject. I have made this list as complete as possible, and although there may be some missing, please message me to let me know!

These pages are designed to be given to students so they can choose their own film, but if you have a special one in mind because of your topic in class, you could always give them a specific movie, watch it in class or have them watch it over the holidays if they want some extra credit!

Bear in mind, I have not checked the ages students need to be according to the different films, so you should check that your students are mature enough to watch the film.

My recommendation is that you review the film in advance, and check that it is available on a streaming platform your students are able to access.

The assignment page gives all the instructions needed to complete the one pager. It is important to know that this assignment is as complete as possible. It can help your students exercise critical thinking when watching science films, discussing morals in film, science progress, famous scientists, climate change...

However, you can choose to make it either physical or digital. That depends on what you want to do! I have included some templates as well in case you want to give a template to your students, or just ideas of how they can lay out a page.

It also includes a rubric as a suggestion for the grading of this assignment. As we teachers know, sometimes we need to adapt the assignment to our own needs. I would insert it directly into Google Classroom, as it calculates the grade automatically. But if you have another way of grading with rubrics, go ahead and let me know!

SCIENCE IN CINEMA

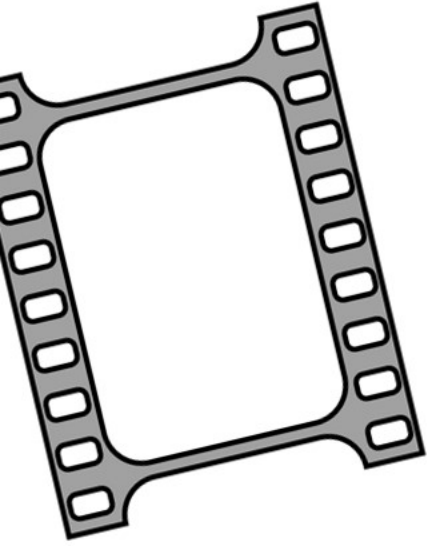

The island
The happening
Jurassic Park
Planet of the apes
The andromeda strain
Lorenzo's Oil
Contagion
Creation
GATTACA
Innerspace
The Meg
Awakenings
Erin Brockovich

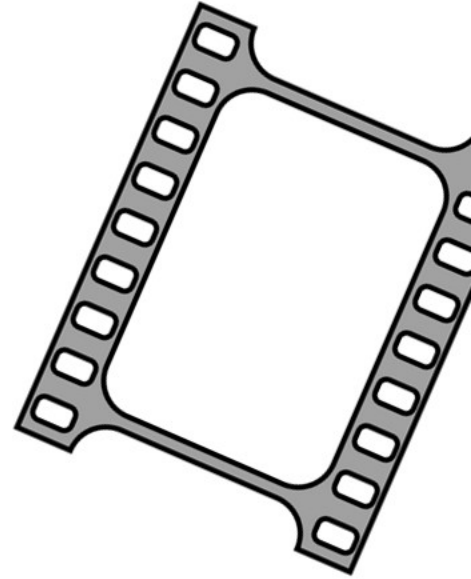

2012

San Andreas

Journey to the center of the earth

The impossible

Dante's peak

The day after tomorrow

The core

I am legend

Angels and demons

Inferno

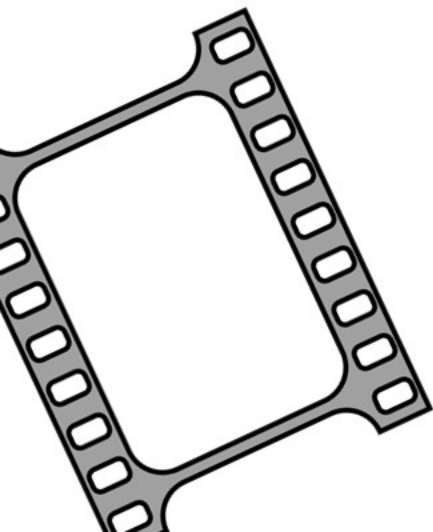

CHEMISTRY IN CINEMA

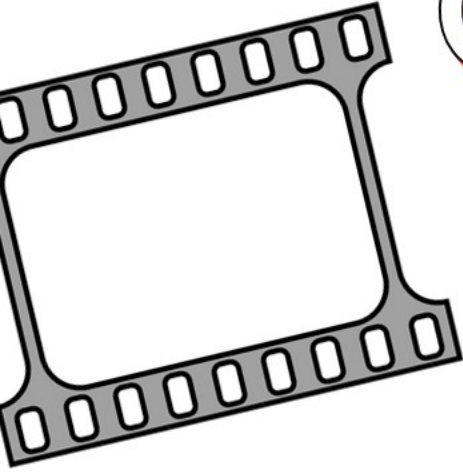

The happening
Jurassic Park
The andromeda strain
Black Panther
Terminator 2
Lorenzo's Oil
Awakenings
Erin Brockovich
Oppenheimer

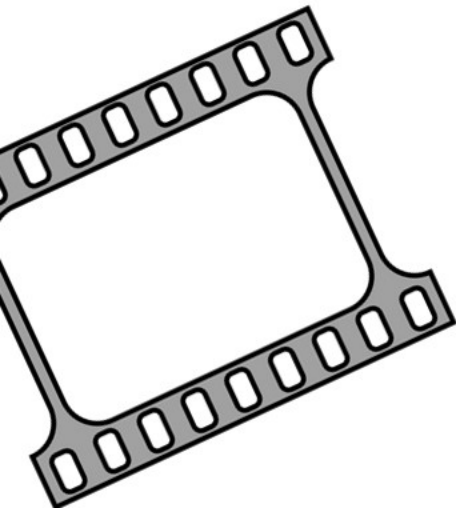
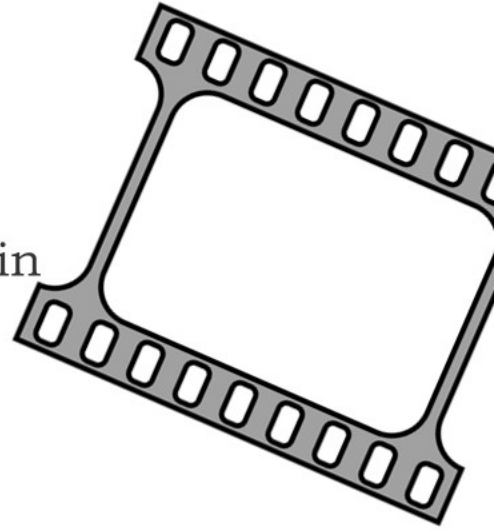

ENGINEERING IN CINEMA

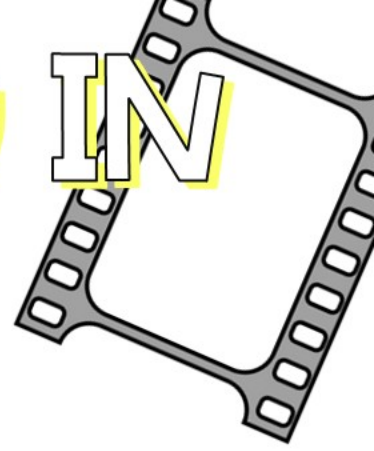
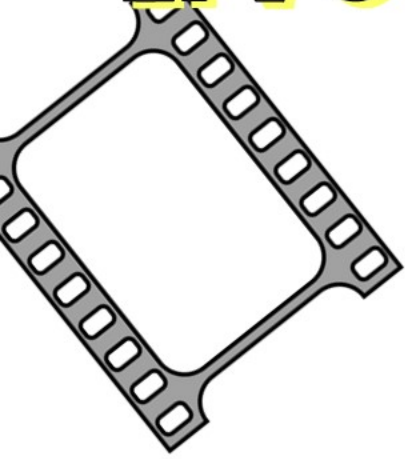

Black Panther

The core

Matrix

Jurassic Park

Bicentennial man

Big hero 6

The Martian

Ex-Machina

Hidden figures

GATTACA

Blade runner

Apollo 13

Blade runner 2049

The imitation game

The theory of everything

Robocop

Interstellar

Artificial Intelligence

Alien

Terminator

Innerspace

Gravity

Star Wars

Total recall

Wall-E

Back to the future

Passengers

Angels and demons

Terminator 2

MATH IN CINEMA

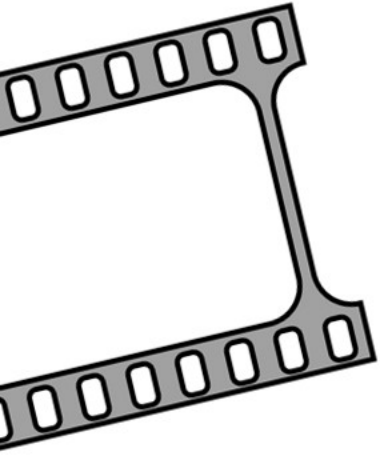

The imitation game

Hidden figures

Agora

Life of Pi

Fermat's room

Good Will Hunting

The Oxford murders

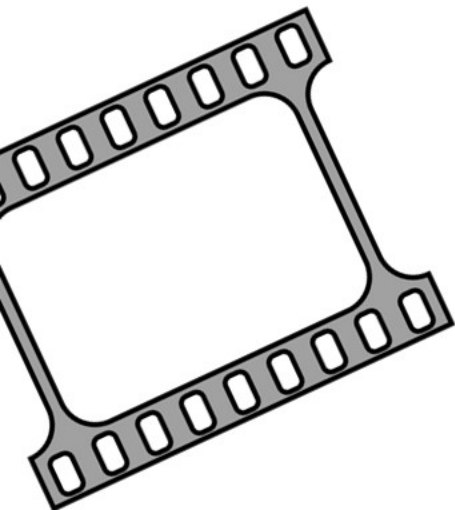
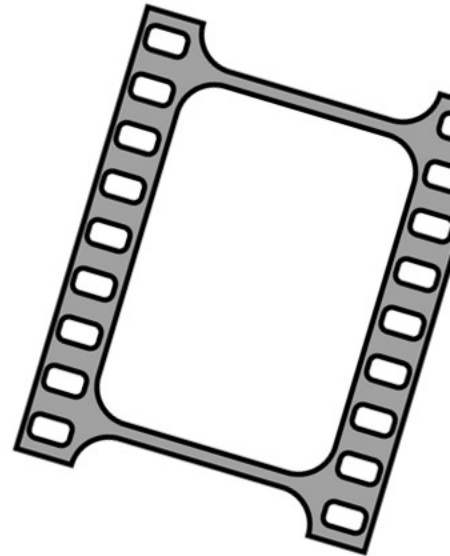

BIOLOGY IN CINEMA

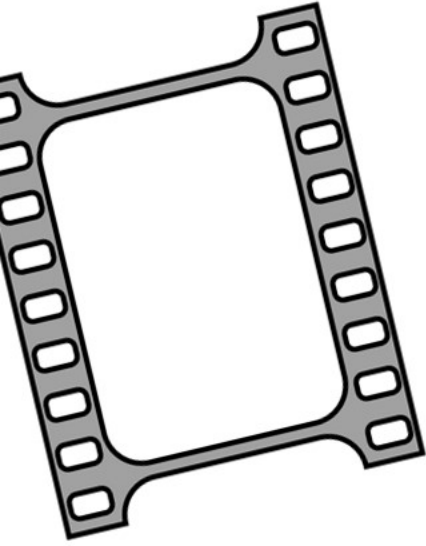

The happening
Jurassic Park
Planet of the apes
The andromeda strain

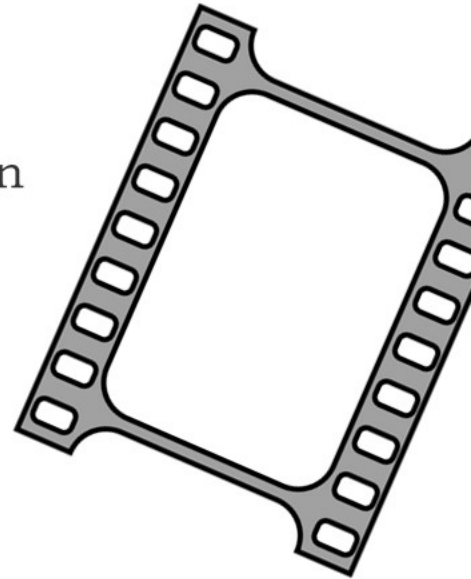

The Martian
Lorenzo's Oil
Contagion
Creation
GATTACA

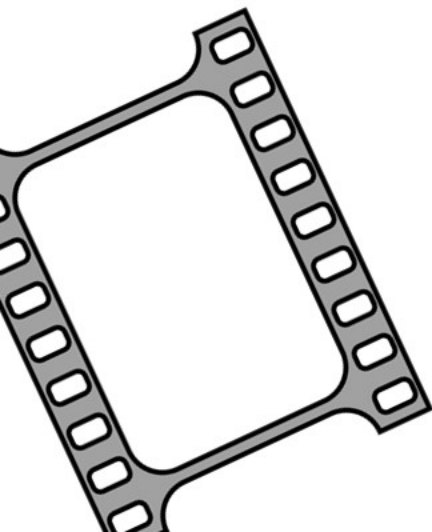

The Meg
I am legend
Awakenings
Erin Brockovich
Inferno
Total recall
Innerspace



GEOLOGY AND CLIMATE CHANGE IN CINEMA

Dante's peak

Journey to the center of the earth

The day after tomorrow

The core

2012

I am legend

Angels and demons

Inferno

San Andreas

The impossible

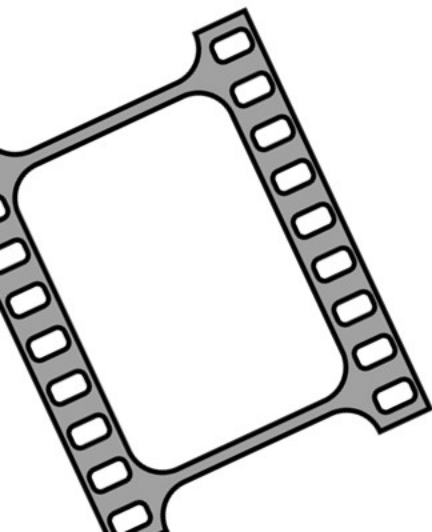
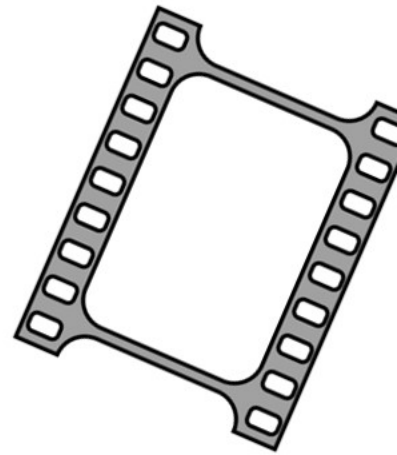

FILM ONE PAGER

MULTIPLE STEM SUBJECTS

You may...

- Use This product in your classroom or for personal use, as many times as necessary.
- Use This product in either physical or digital form.
- Share your use of This product on social media as long as you attribute the author.

You may not...

- You must not share This file/resource with anyone unless they have purchased additional licences.

FILM ONE PAGER

MULTIPLE STEM SUBJECTS

If you have any question, comment or suggestion, you can write me an email at makestemprovid@gmail.com

GO
to the
BLOG

WHERE ELSE
can I
FIND YOU?

TEACHERS
pay
TEACHERS

GO
to the
HOME PAGE

Credits...

